

TECHNICAL GUIDE

Pressure Relief Devices



Content index

Application	4
Technical data	5
Connection data	6
Mechanical test	9
Dimensions.....	11
Order sheet (type T - M).....	18
Order sheet (type 170S)	19

Application

Application volume of oil [dm ³]	Size [mm]	Model type	Protection type	Cover material	Corrosion protection C4 Medium	Corrosion protection C5 Medium	Corrosion protection CX Off Shore
Up to 3,000	50	T	Guard	Plastic	●	-	-
		T	Conveyor duct	Stainless Steel	●	*	-
		M	Conveyor duct	Aluminum alloy	●	●	-
Up to 9,000	80	T	Guard	Plastic	●	-	-
		T	Conveyor duct	Stainless Steel	●	*	-
Up to 25,000	125	T	Guard	Plastic	●	-	-
		T	Conveyor duct	Stainless Steel	●	*	-
Up to 43,000	170	170SB	Guard	Stainless Steel	●	*	-
		170SC	Conveyor duct	Aluminum alloy	●	●	●
		170SD	Swiveling conveyor	Stainless Steel	●	*	-
		e170SC	Conveyor duct	Aluminum alloy	●	●	●

* Valve body in C5 Medium and conveyor duct in stainless steel 316L

Technical data

Model type	kPa	PSI
Type M and Type T	from 20 to 200 kPa	from 2.90 up to 29 PSI
Type 170S	from 30 to 170 kPa	from 4.35 up to 25.38 PSI
Materials		
Flange	Seawater resistant cast aluminum	
Cover	Plastic, stainless steel or aluminum	
Conveyor duct	Stainless steel or aluminum	
Gaskets (in contact with oil)	NBR (only solution available for type 170S), Viton, HNBR *	
Standard	IEC 60076-22-1	
Ambient temperature	From -40°C up to +80°C	
Micro - switches		
Contacts	170 SB/170 SD/ T: Per micro-switches: 1 x NO and 1 x NC (up to 3)	
	170 SC/e170SC/ M: Per micro-switches: 1 x Change over (up to 3)	
Utilization category	IEC 60947-5-1: AC-15 / DC-13	
Contact load	170 SB/170 SD/ T - As per IEC 60947-5-1: AC: 250 V / 6A, DC: 250 V / 0.3 A; 125 V / 0.55 A 170 SC/e170SC/ M - As per IEC 60947-5-1: AC: 250 V / 5A, DC: 250 V / 0.3 A; 125 V / 0.6 A	
Max continuous current	10 A (making capacity)	
Rated insulation voltage	AC: 2.5 kV / 1 min	

* The valve T with stainless steel conveyor duct the gasket between the tank and the valve is made of cork rubber

Connection data

Model types: T, 170SB and 170SD

Contact position

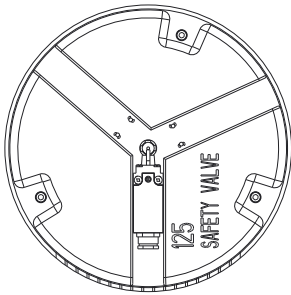

1 contact

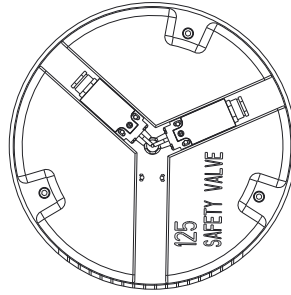

2 contact

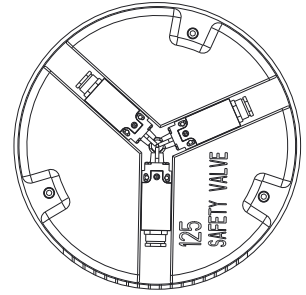

3 contact

Electrical scheme

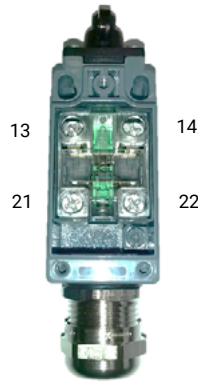
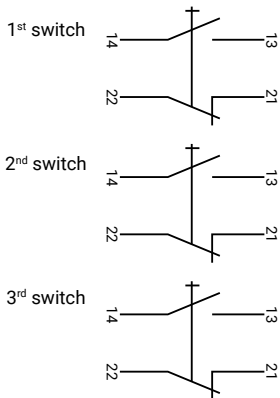

Contact configuration

Connection data

Cable gland	M20x1.5 – nickel plate brass
Degree of protection	IP67 acc. to IEC 60 529
Terminal clamps	Single core: 0.5...2.5mm ² , AWG 20-10 or Lead with ferrule: 0.5...1.5mm ² , AWG 20-15

M and 170 SC model types

Contact position

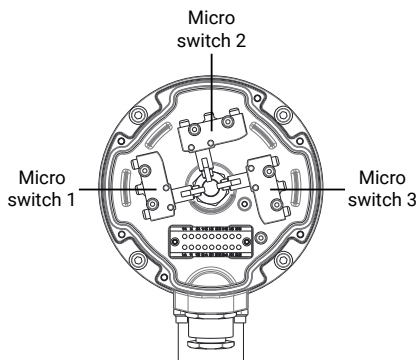

Electrical scheme

Connection data

Cable gland	M25x1.5 – nickel plate brass
Degree of protection	IP65 acc. to IEC 60 529 IP67 : Option only for Comem 50M
Terminal clamps	Single core: 0.5...2.5mm ² , AWG 20-10

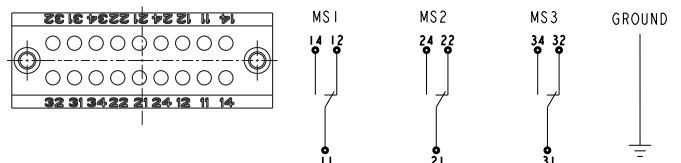

Plug-in connector (ANSI type) 170SB and 170SD

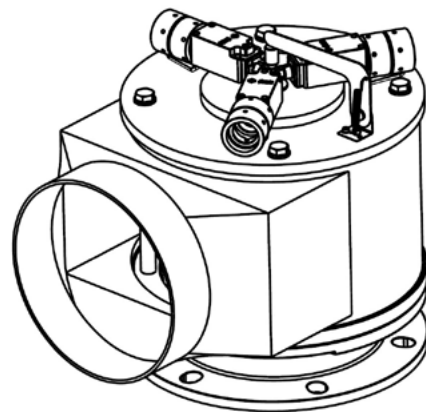
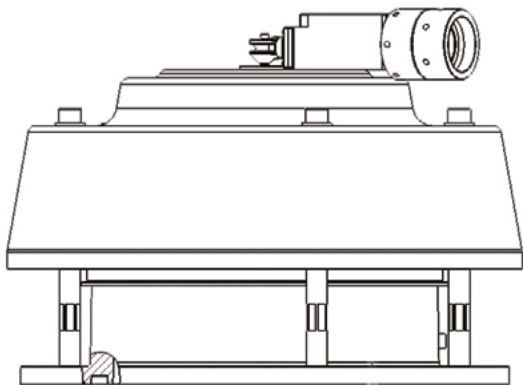

Plug-in connection scheme

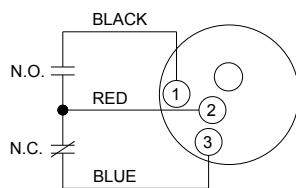

Connection data

e170SC scheme

Contact position

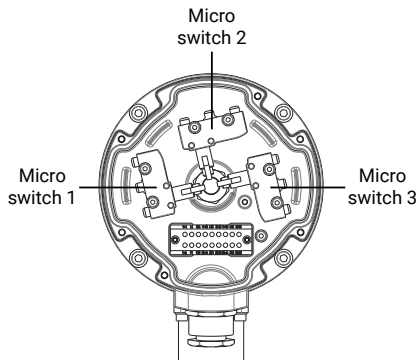

Electrical scheme

Connection data

Cable gland	M25x1.5 – nickel plate brass
Degree of protection	IP65 acc. to IEC 60 529
Terminal clamps	Single core: 0.5...2.5mm ² , AWG 20-10

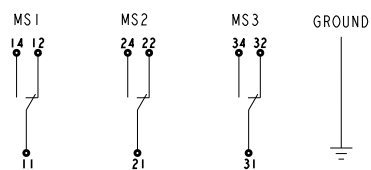

Electronic board connection

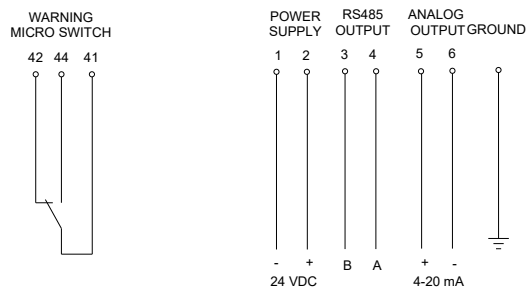

1 x Alarm change over contact: Pre-alarm signal (terminal 42-44-41). The contact switches when the value of the pressure gets over the value adjusted. It is possible to adjust this value through a trimmer on the electronic board or by Modbus.

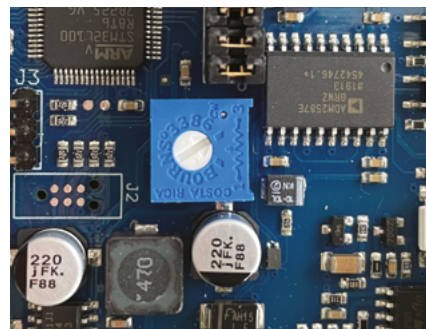

Technical data

Cable gland	M25x1.5 – nickel plate brass
Degree of protection	IP 65 acc. to IEC 60 529
Wires	Max 2.5mm ² – advised 4x1mm ² o 6x1mm ² shielded twisted pair cable for analog/digital output
Ventilation valve	To prevent the formation of condensation
Rated voltage	24 VDC ±10% polarized
Power consumption	0.5 W
Output	4-20 mA and Modbus (dielectric strength between electronic card and analog output: 1kV)
Ambient temperature	from -40°C up to +80°C

Mechanical test

Mechanical test – T type

Position "Operation"

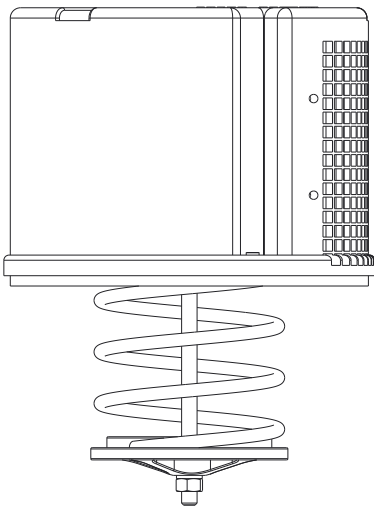

Position "Alarm"

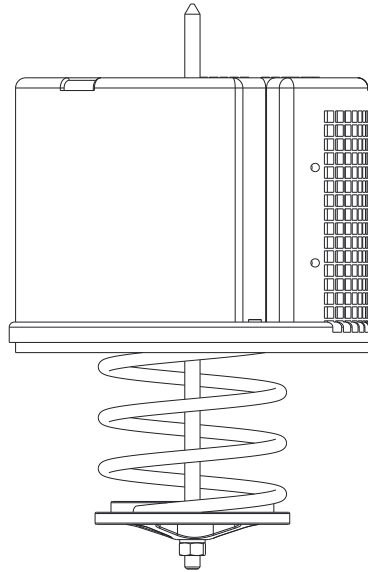

Materials

Stem	Brass
------	-------

Mechanical test – M, 170Sc and e170SC types

Position "Operation"

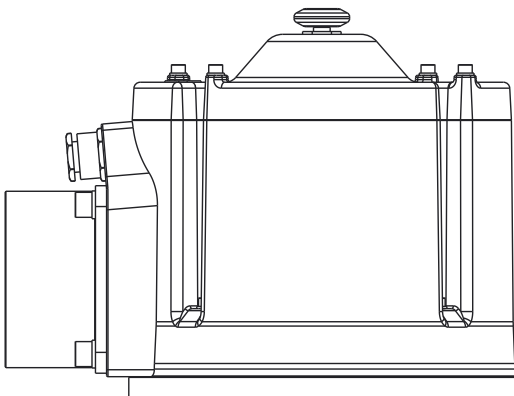

Position "Alarm"

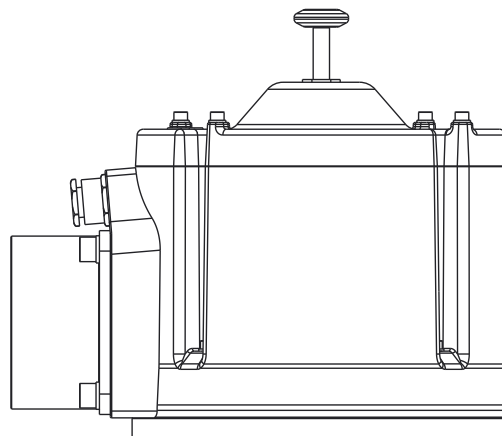

Materials

Stem	Stainless steel
Optical cork	Red painted aluminum

Mechanical test

Mechanical test – 170SB and 170SD type

Position “Operation”

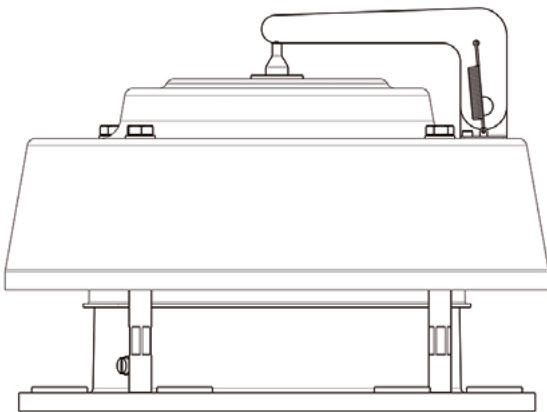

Position “Alarm”

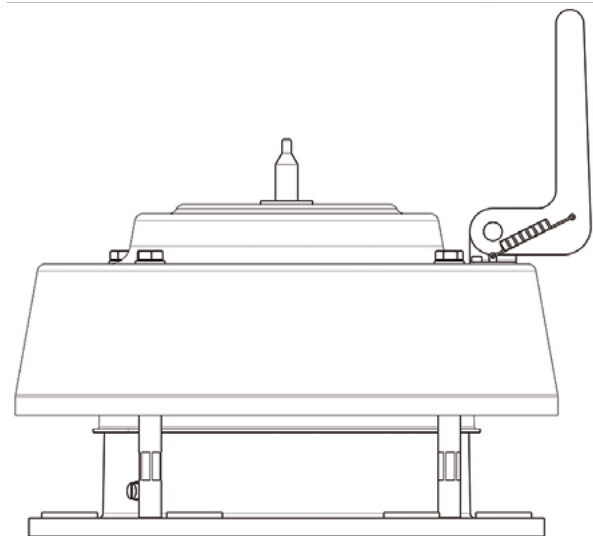

Materials

Stem	Polyoxymethylene(POM)
------	-----------------------

Dimensions

T type with guard

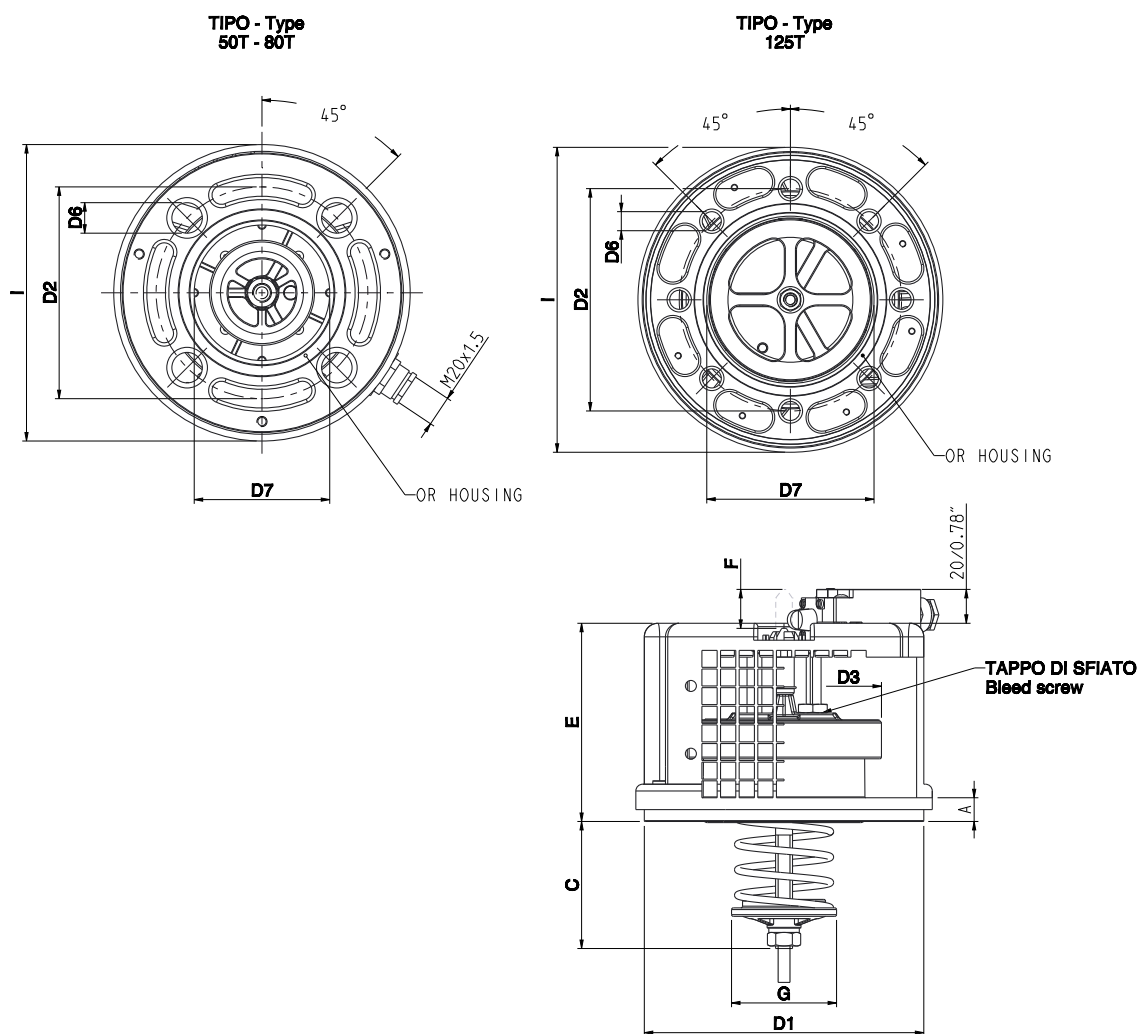

Type	G (mm)	A (mm)	D1 (mm)	D2 (mm)	D3 (mm)	D6 (mm)	D7 (mm)	Cmax 20-70 kPa	E (mm)	I (mm)	Fmax (mm)	OR Housing (mm)	Weight (Kg)
50T	62	14	165	125	116	18	80	95-60 mm	130	175	16	OR6337-Ø99xØ85x4	2.1
80T	100	16	200	160	150	18	109.5	105-75 mm	140	210	32	OR199-Ø131xØ117x4	3.8
125T	153	16	278	210	206	18	158	145-65 mm	210	288	62	OR8650-Ø182xØ164x5	6.7

Type	G (inch)	A (inch)	D1 (inch)	D2 (inch)	D3 (inch)	D6 (inch)	D7 (inch)	Cmax 2.90-10.15PSI	E (inch)	I (inch)	Fmax (inch)	OR Housing (inch)	Weight (Kg)
50T	2.44	0.55	6.50	4.92	4.57	0.71	3.15	3.74"-2.36"	5.12	6.89	0.63	OR6337-Ø3.90xØ3.35x0.16	2.1
80T	3.94	0.63	7.87	6.30	5.90	0.71	4.31	4.13"-2.95"	5.51	8.27	1.26	OR199-Ø5.16xØ4.61x0.16	3.8
125T	6.02	0.63	10.94	8.27	8.11	0.71	6.22	5.71"-2.56"	8.27	11.34	2.44	OR8650-Ø7.16xØ6.46x0.20	6.7

Dimensions

Conveyor duct T type

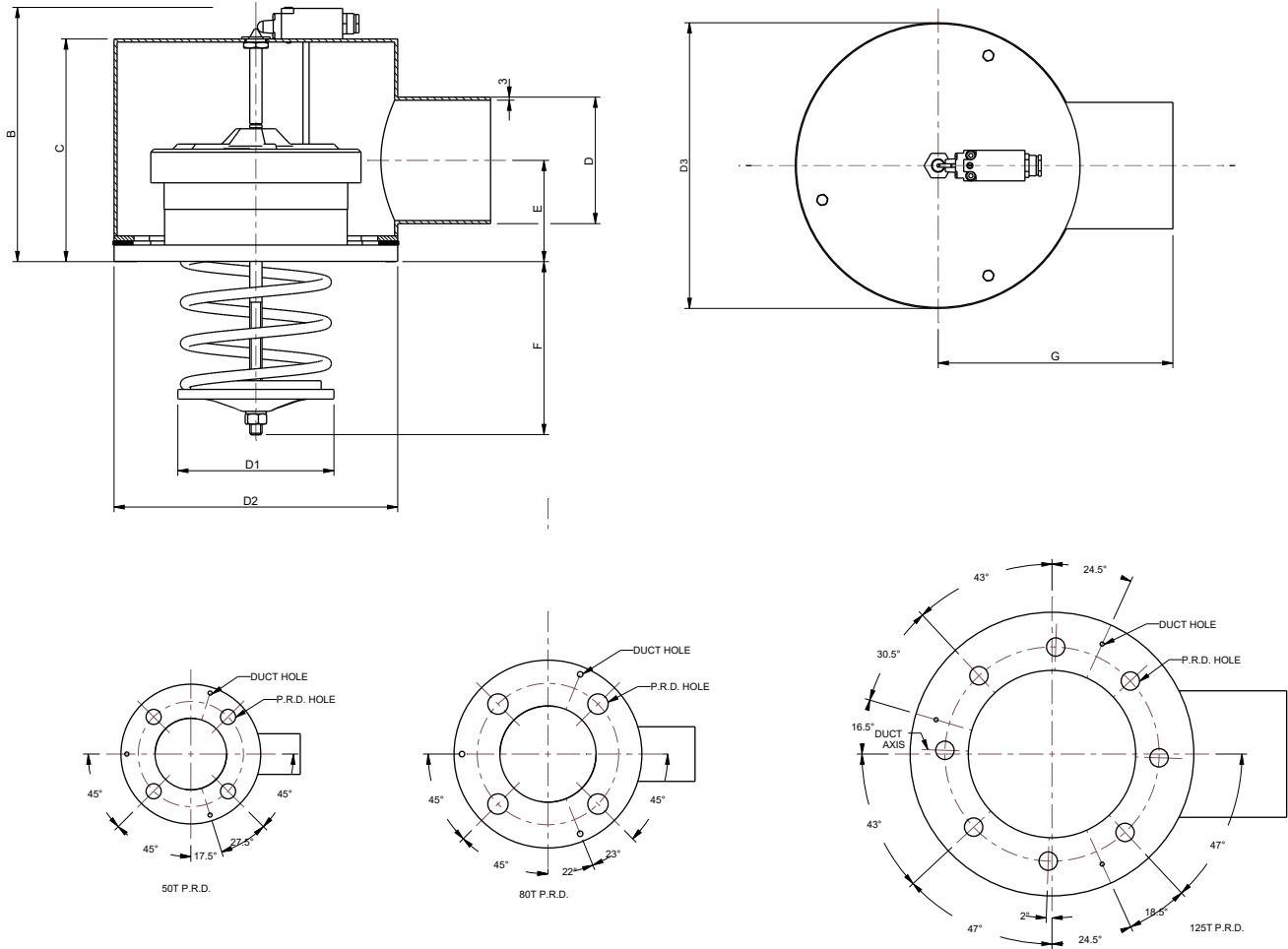

Type	B (mm)	C (mm)	D (mm)	D1 (mm)	D2 (mm)	D3 (mm)	E (mm)	F (mm)	G (mm)
50T	152	125	Ø48.3	Ø62	Ø165	Ø166	53.5	85	130
80T	170	140	Ø76.1	Ø100	Ø200	Ø201	72	90	182
125T	260	225	Ø124	Ø153	Ø278	Ø278	99	175	230

50M type

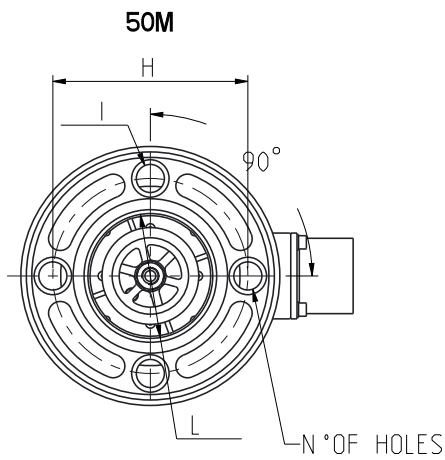
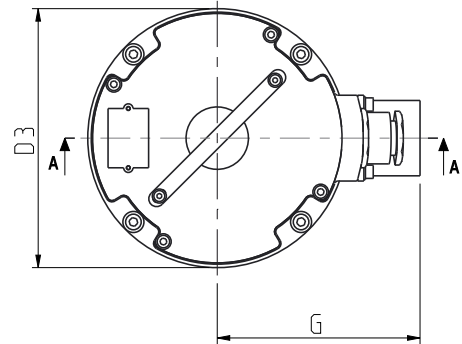
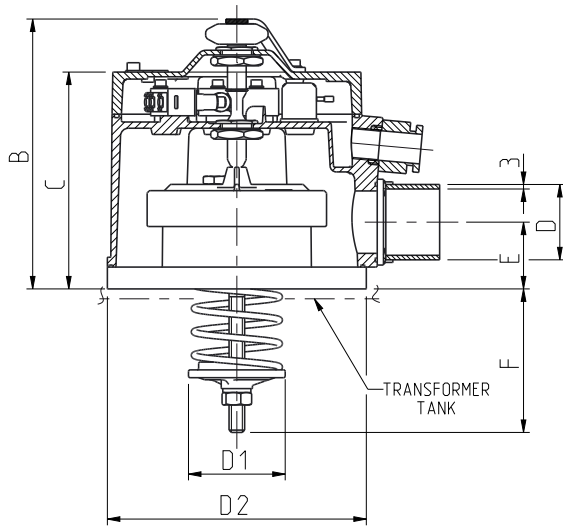

Type	Weight (Kg)
50M	2.1

Type	B (mm)	C (mm)	D (mm)	D1 (mm)	D2 (mm)	D3 (mm)	E (mm)	F 20-70 kPa	G (mm)	H (mm)	I (mm)	L (mm)	Holes
50M	170	139	Ø48.3	Ø62	Ø165	Ø166	41.5	85-45 mm	130	Ø125	18	80	4

Type	B (inch)	C (inch)	D (inch)	D1 (inch)	D2 (inch)	D3 (inch)	E (inch)	F 20-70 kPa	G (inch)	H (inch)	I (inch)	L (inch)	Holes
50M	6.69"	5.47"	Ø1.90"	Ø2.44"	Ø6.49"	Ø6.53	1.63"	3.35"-1.77"	5.12"	Ø4.92"	0.71"	3,15	4

Dimensions

170SB type

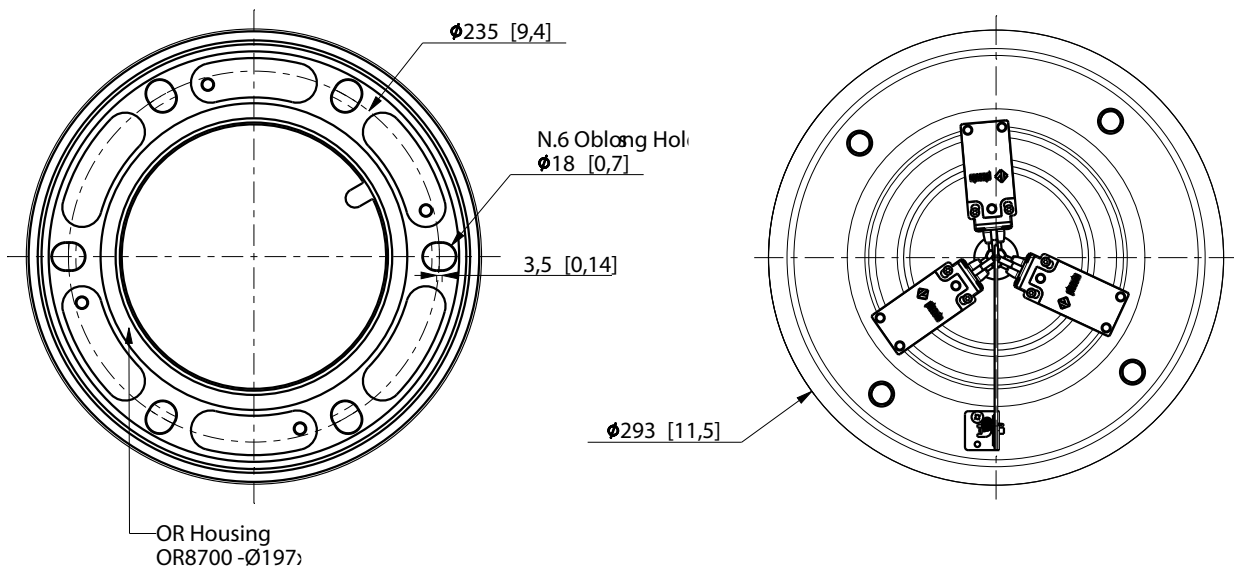
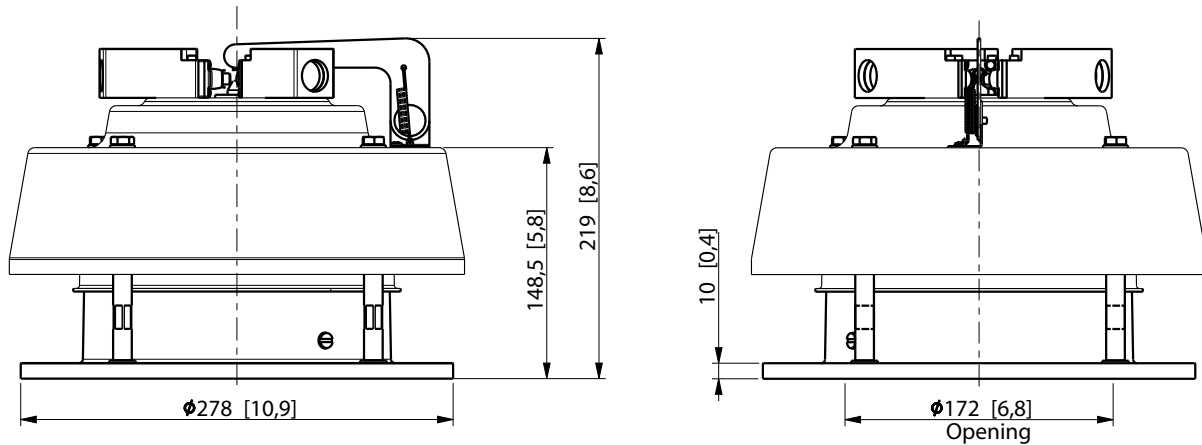

Note:
Dimensions are for reference and shown in millimeters[inches].

Type	Weight (Kg)
170SB	8.5

170SC type

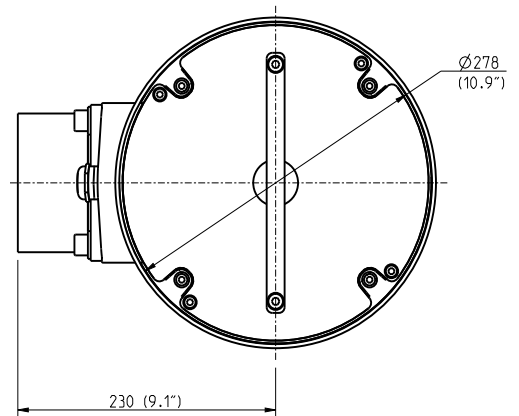
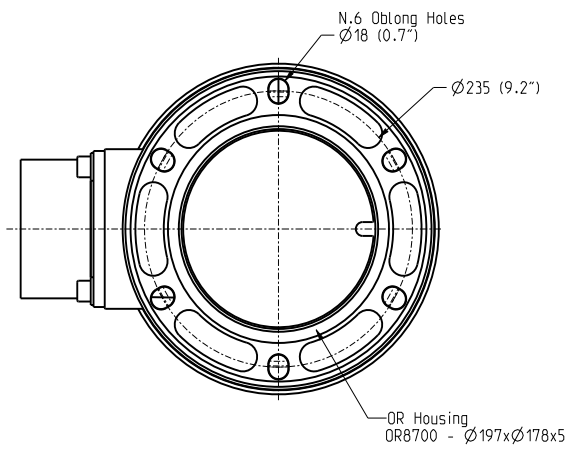
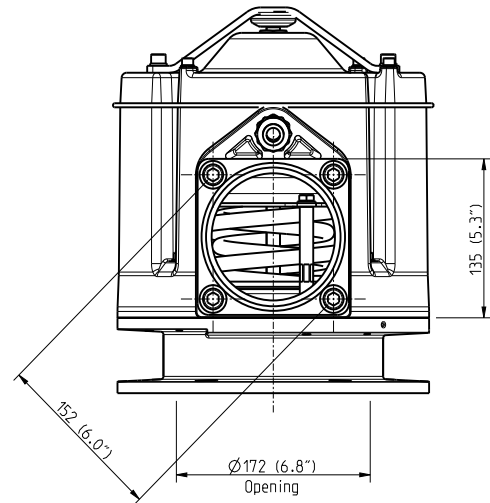
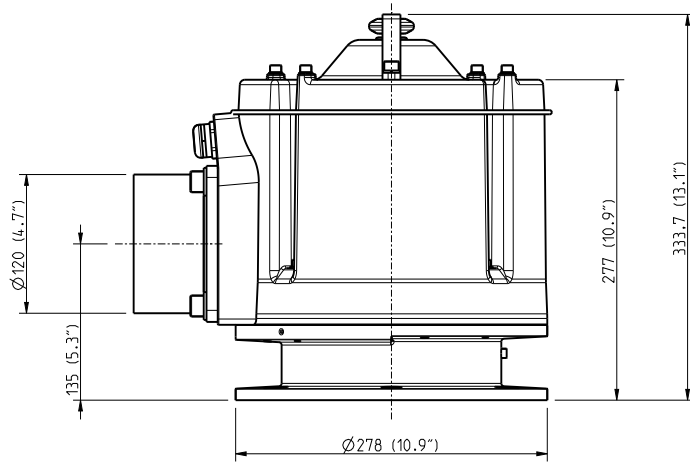

Note:
Dimensions are for reference and shown in millimeters[inches].

Dimensions

e170SC type

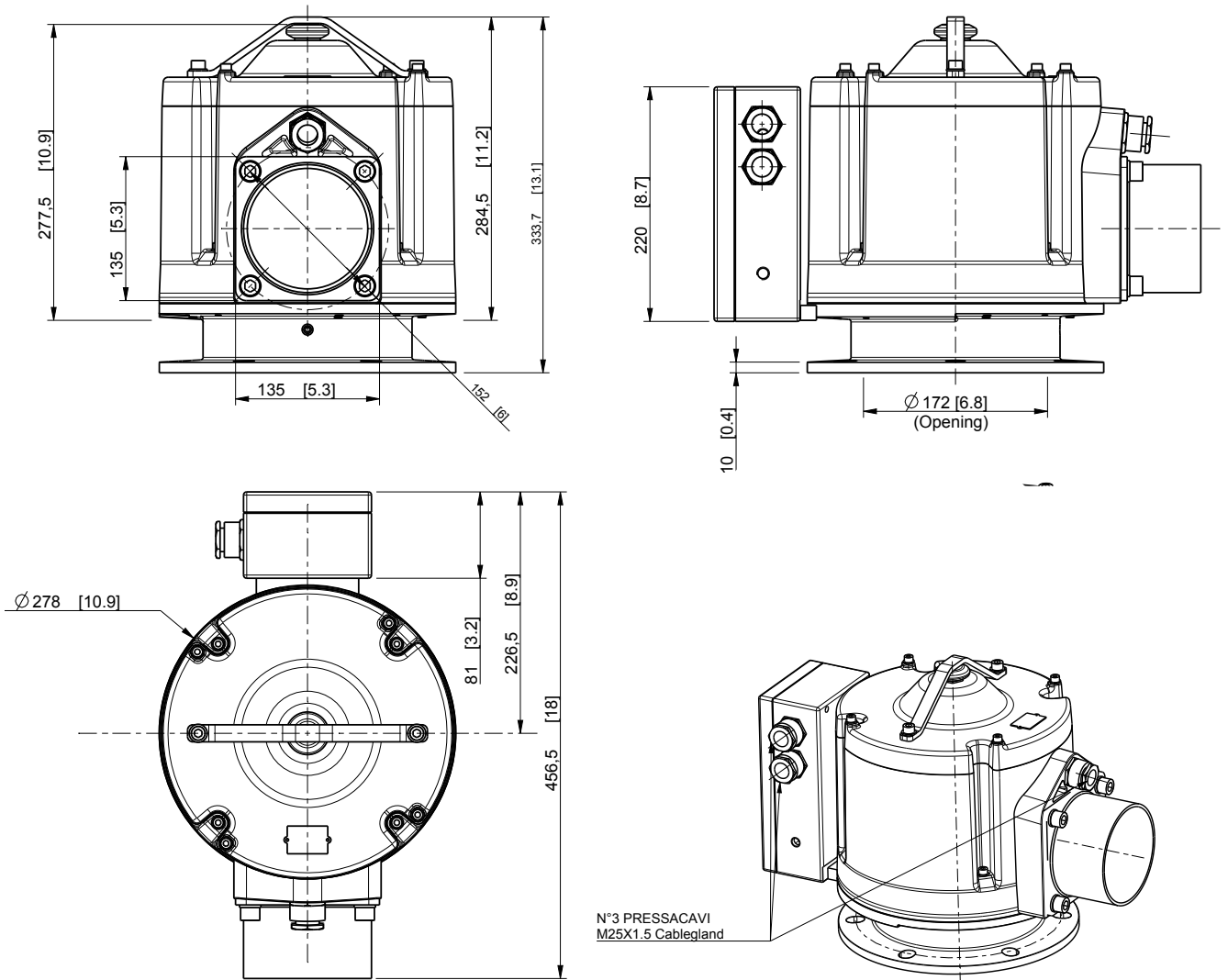

Note:
Dimensions are for reference and shown in millimeters[inches].

Type	Weight (Kg)
e170SC	20

170SD type

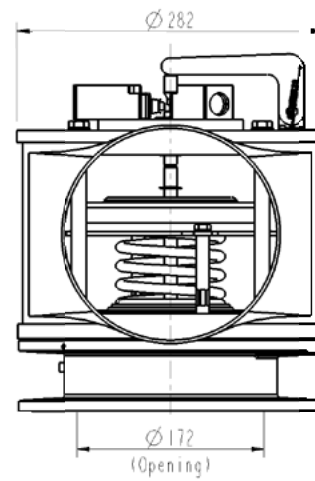
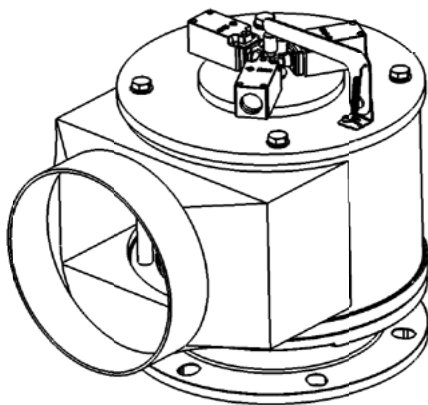
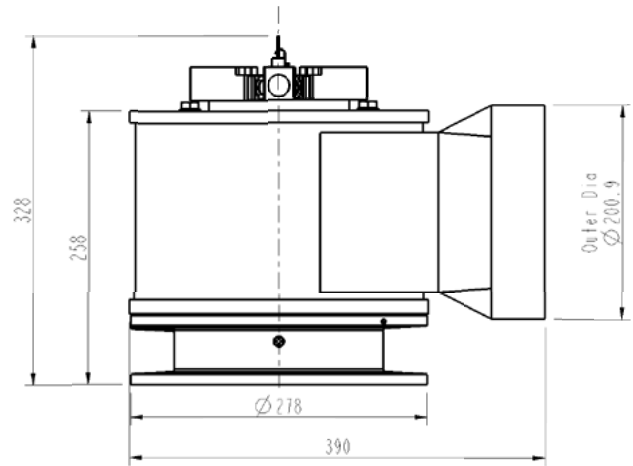
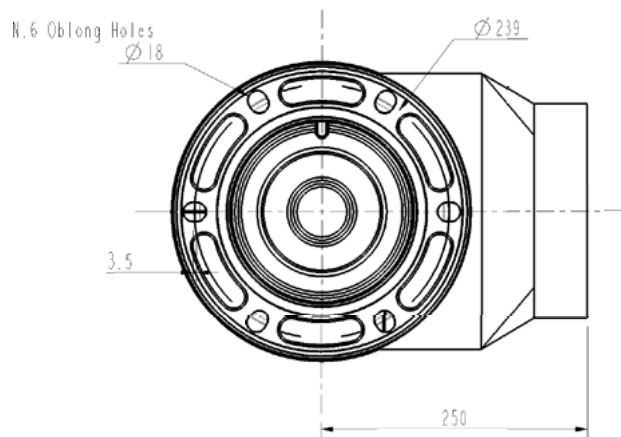

Note:
 Dimensions are for reference and shown in millimeters[inches].

Type	Weight (Kg)
170SD	14

Order sheet (type T - M)

Date	
Rev.	
Customer reference	

Type	Available sizes
T	All
M 4 holes	50

Size
50 mm
80 mm
125 mm

No. of switches	Notes
0	only with plastic guard
1	-
2	-
3	-

Cover ⁽¹⁾	Material	Type
Guard	Plastic	T
Conveyor duct	Stainless steel	T
Conveyor duct with pipe	Aluminum	M
Conveyor duct without pipe	Aluminum	M

(1) see below

Operating pressure	Note
20 kPa	
30 kPa	
40 kPa	
50 kPa	
60 kPa	
70 kPa	
80 kPa	
90 kPa	
100 kPa	
140 kPa	
175 kPa	
200 kPa	

Only for Size 50

Gasket (only in contact with oil)

NBR (standard)	-40°C to + 120°C
HNBR (only for 50T and 50M)	-40°C to + 140°C
Viton	-10°C to +150°C

Corrosion protection class

C4 acc. to ISO 12944 (Standard)
C5-Medium acc. to ISO 12944 (Not paintable)

**Guard
(T type)**

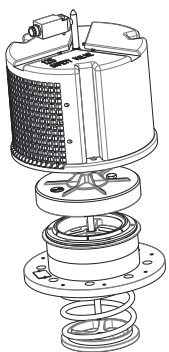

**Conveyor duct
(T type)**

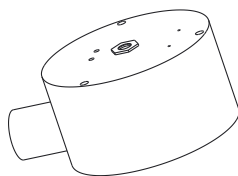

**Conveyor duct with pipe
(M type)**

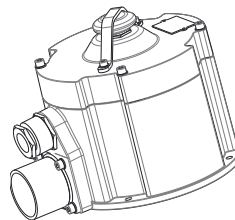

**Conveyor duct without pipe
(M type)**

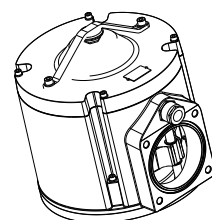

For further information or clarification, please contact our support team:
E-mail address: customerservice@it.comem.com

Order sheet (type 170S)

Date	
Rev.	
Customer reference	

Type	Oil Discharge	Analog and Digital output
170SB	-	-
170SC	Conveyor duct	-
170SD	Swiveling conveyour	-
e170SC	Conveyor duct	4-20 mA and Modbus

No. of switches	Notes
0	only 170SB
1	-
2	-
3	-

Plug-in connector (ANSI type ⁽¹⁾) available only for 170SB and 170SD	
Yes	
No	

(1) for details see page 7

Conveyor duct ⁽²⁾	Material	Type
With pipe	Aluminum	only for 170SC and e170SC
Without pipe	Aluminum	only for 170SC and e170SC

(2) see below

Operating pressure
30 kPa
40 kPa
50 kPa
60 kPa
70 kPa
80 kPa
90 kPa
120 kPa
140 kPa
170 kPa

Semaphore		
Available only for 170SB and 170SD	Yes	No

Corrosion protection class
C4 Medium acc. to ISO 12944 (RAL 7032)
C5 Medium acc. to ISO 12944 (Not paintable)
CX acc. to ISO 12944 (RAL 7035) (only for type 170SC/e170SC)

170SB

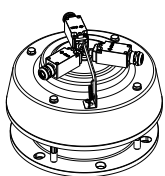

170SC with pipe

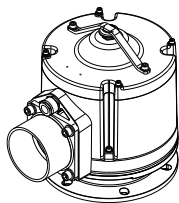

e170SC with pipe

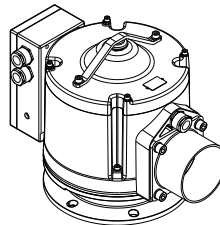

170SC/e170SC without pipe

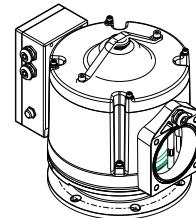

For further information or clarification, please contact our support team:
E-mail address: customerservice@it.comem.com

COMEM SpA

Localita' Signolo 22, S.R.11
36054 Montebello Vicentino
Vicenza - Italy
Tel +39 0444 449 311

www.comem.com

The data and illustrations are not binding. We reserve the right to modify the contents of this document without prior notice following the technical and product developments.

Copyright 2026 COMEM. All rights reserved

Technical guide-01-2026